

TubePro™

A simple guide to creating your first report

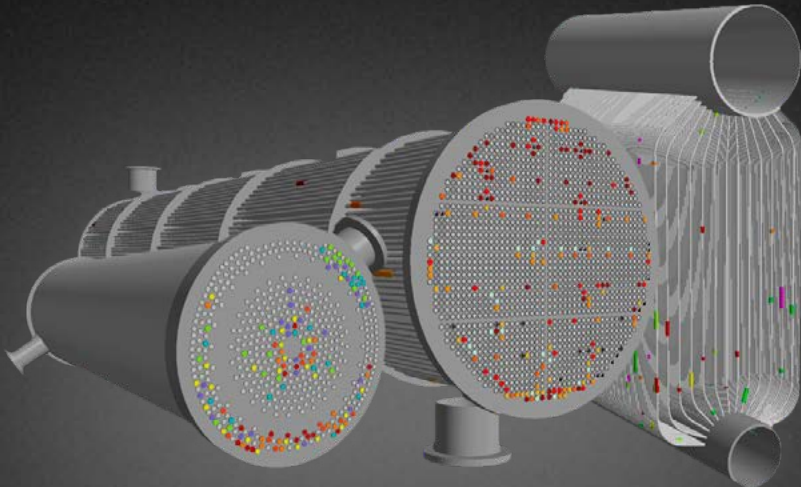

TABLE OF CONTENTS

1.	Overview	4
1.1	Interface description.....	4
1.1.1	Project Sections menu.....	4
1.1.2	Main Ribbon	4
1.1.3	Quick access toolbar	4
1.1.4	Project Browser.....	5
1.2	General functions	5
1.2.1	Creating a project.....	6
1.2.2	Measurement units.....	6
1.2.3	Decimal mark	6
1.2.4	Button description.....	7
1.2.5	Moving in a view	7
2.	Creating a Tube map	7
2.1	Automatic photo detection.....	7
2.1.1	Using a drawing for detection.....	8
2.2	Tube auto-detection based on a photo	9
2.2.1	Rotating the photo.....	9
2.2.2	Tilting the photo.....	10
2.2.3	Specifying the scale on a photo.....	10
2.2.4	Set the OD for all the tubes.....	11
2.3	Inserting a rectangular block of tubes.....	12
2.4	Inserting a single tube.....	14
2.5	Selecting tubes	14
2.6	Moving tubes	14
2.7	Deleting tubes	15
2.8	Aligning a selection of tubes.....	16
2.9	Adjusting the numbering	17
2.10	Creating and assigning a section.....	20
2.11	Exporting a tube list.....	21
3.	3D Model.....	22
3.1	Display functions	22
3.2	Tube properties	23

3.3	Tube sheet Geometry.....	24
3.4	Support plates.....	25
3.5	Nozzles	25
3.6	U-Bends.....	26
4.	Inspection Data	27
4.1	Importing data from an acquisition software	27
5.	Drawings	27
5.1	Adding a drawing page.....	28
5.2	Changing a drawing page layout.....	28
5.3	Inserting an element in a drawing	29
5.4	Create an element.....	30
6.	Report	31
6.1	Page Layout	32
6.2	Inserting a field	32
6.2.1	Drag and drop method:.....	32
6.2.2	Double-click method:	32
6.3	Creating a field	32
6.4	Inserting an element.....	33
6.5	Exporting a report	33
6.5.1	3D model in the report	34

1. OVERVIEW

1.1 Interface description

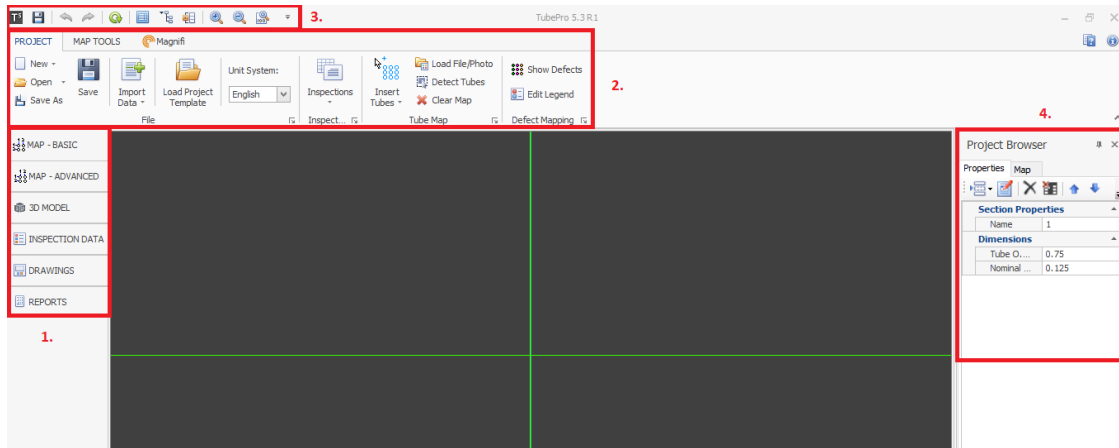

1.1.1 Project Sections menu

On the left-hand side of the interface, you can access the different sections used to create a Project. Depending on the tab selected, the ribbons accessible are changed.

1.1.2 Main Ribbon

On the upper part of the screen, you can find the ribbon. The ribbon contains different tabs, each with different functions. This is where you will find the tools to perform your desired actions.

1.1.3 Quick access toolbar

On top of the ribbon is the quick access toolbar. This toolbar contains several handy functions to facilitate the use of *TubePro*. The *Quick Access Toolbar* can be customized.



- A. **Undo/Redo:** The left arrow allows you to undo the last action you performed, and the right arrow cancels the last undo.
- B. **Refresh:** Refreshes the main report.
- C. **Project Browser shortcuts:** The left symbol opens the properties tab in the *Project Browser* and the right symbol displays the *Project Browser* on the right side of the screen.
- D. **Macros:** Opens the *Macro Manager* window which allows the user to modify/add macros and counters.

- E. **Zoom options:** The first two symbols allow the user to zoom in and out in a view, which can also be done using the mouse wheel. The last symbol makes the view fit to the main window.

1.1.4 Project Browser

On the right-hand side of the interface, you can find the *Project Browser*. The *Project Browser* gives information on the current view and contains customizable fields. The tabs in the *Project Browser* change depending on the current subsection.

1.2 General functions

These are some basic functions that need to be explained in order to use *TubePro* efficiently. First off, here are the differences between a Template and a Project file:

1. **TupePro Project File:** A file that contains all the elements of a report including the tube sheet map, the properties and the data. The extension is T5PRJ.
2. **TubePro Project Template:** A file that contains all the elements of a report but without the tube sheet map layout, nor the data sets. The drawings, graphs, tables and spreadsheets are included and just need to be refreshed with the newly created tube sheet. The properties are also kept. The extension is T5TPL.

The following table lists the components that each file contains:

	Project Template (T5PRL)	Project File (T5PRJ)
Tube sheet	No	Yes
Picture used to create the Tube sheet	No	Yes
3D Model	No	Yes
Inspection Data	No	Yes
Properties	Yes	Yes
Drawings	Yes**	Yes
All the Project items: - 3D Model views - Spreadsheets - Legends - Charts - Plugged Tube Ratio (PTR) diagram	Yes**	Yes
Macros	Yes	Yes
Report	Yes**	Yes

**These features need to be updated with the appropriate inspection data once you create a new *Project File* with a *Project Template*.

In summary, the *Project Template* contains the general structure of your report. Having a template separate from your *Project File* allows you to build multiple reports with the same layout. The *Project File* is the file that contains your data and is created for each of your inspections.

1.2.1 Creating a project

There are two ways to create a project. You can either create a project without any template structure or you can create a project with a template that you've previously designed.

Click on the *New* button under the *PROJECT* tab and select the desired option.

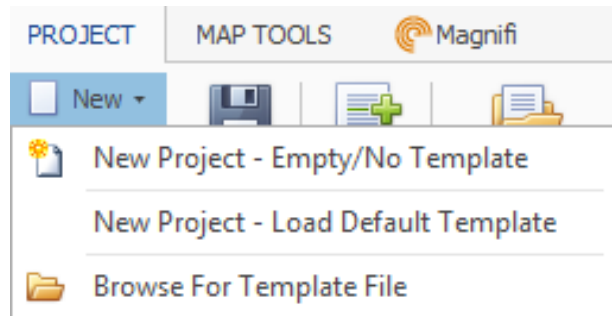

If you are using TubePro for the first time, it is recommended to create a project with a default template. It already includes relevant fields and it can be modified to match your requirements.

1.2.2 Measurement units

The measurement units can be changed from different location. First access MAP-Basic, 3D MODEL, INSPECTION DATA, DRAWINGS or REPORTS. In each of these sections, in the main Ribbon, select the *PROJECT* tab and select the desired unit from the drop-down list.

*** It's important to change the units in each section AND change it before creating tubes or importing data.

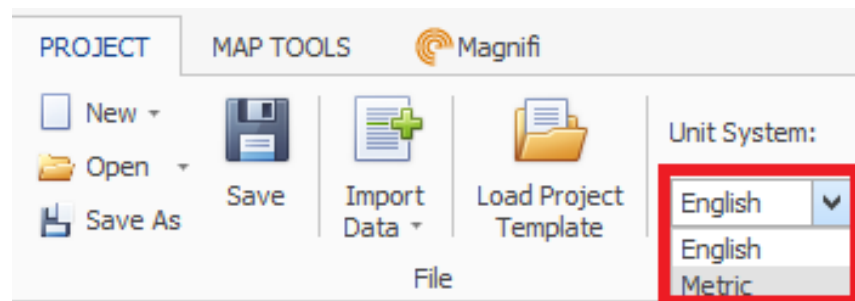

The system will show the length measurement in inches or in millimeters accordingly.

This option does not modify the values imported in your report. If you switch from a unit to another, the indications locations won't be modified to match the unit modification.

1.2.3 Decimal mark

To choose the appropriate decimal mark that is coherent with your computer settings, you have to set it. Go to *REPORT* side menu, in the ribbon, select the *REPORT* tab. There is a dropdown list where you can choose the format that you want to use.

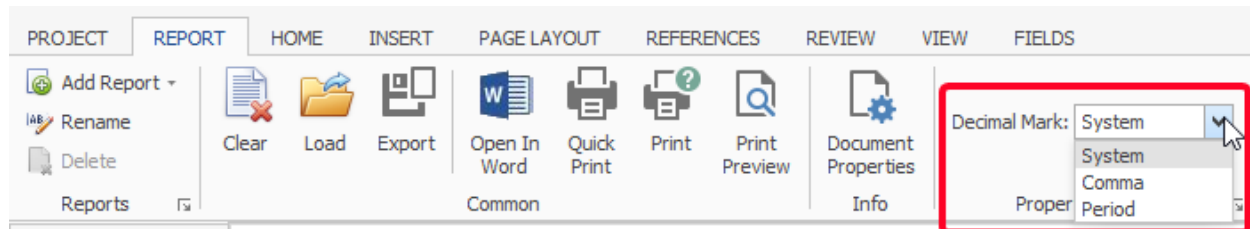

1.2.4 Button description

To get a short description of a button you can place the cursor over it.

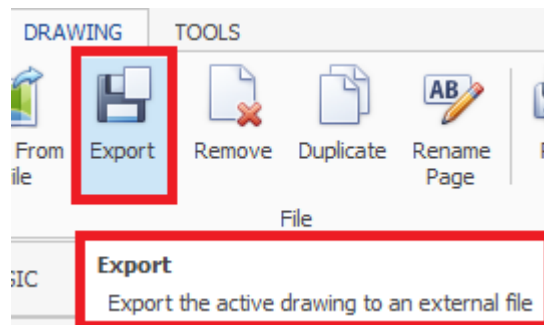

1.2.5 Moving in a view

- Translation: hold right mouse button.
- Zoom in and out: Use mouse wheel.
- Move a 3D model: Hold mouse wheel button and move mouse.

2. CREATING A TUBE MAP

The following functions can be found in the *MAP - ADVANCED* tabs. They are used to build a tube sheet of an exchanger and to define the tube numbering order.

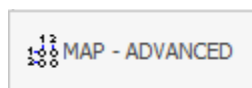

There are 2 different workflows to creating a tube sheet. The first one is to automatically detect the tubes on a picture or a PDF. This a very fast and useful method.

The second is to manual insert the blocks in rectangular and/or circular. To learn out to do it, jump down to 2.3.

2.1 Automatic photo detection

A photo of an exchanger can be imported in the main window of the Map tab and TubePro can automatically detect the tubes on it.

To facilitate the detection, we suggest being as parallel as possible to the tube sheet and use the maximum picture quality possible.

To load the photo, first navigate to the *PHOTO* tab and click on LOAD icon.

In the dropdown menu, user must choose between *Photos* or *Drawings*.



This distinction between the two types of files is important because it changes the algorithms of detection. A photo is a picture, such as a .jpeg, while a drawing is a file in the .pdf format. Section 2.1.1 will present the workflow for a PDF and will be for a picture.

2.1.1 Using a drawing for detection

When importing a drawing, the following window appears.

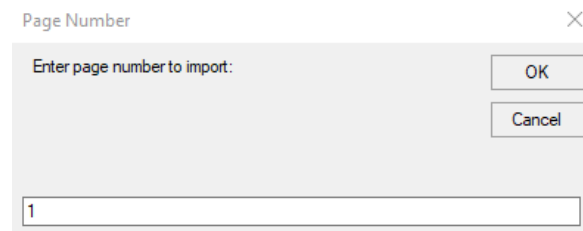

Enter the page number where the drawing is in the PDF file. Once this is done, another window appears:

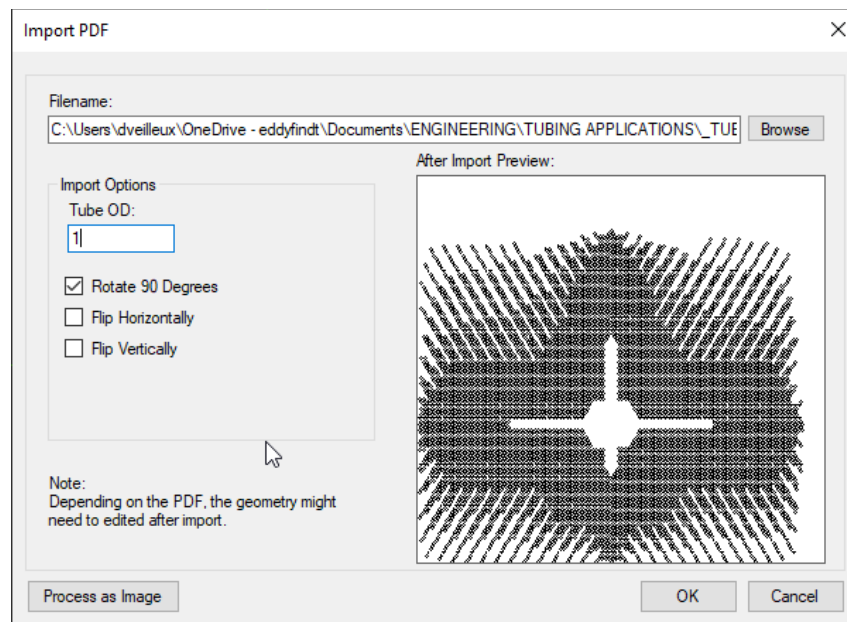

In this menu, you can set the outside diameter (OD) of your tubes and you can rotate and flip the drawing before it's displayed in the tube map. Once the necessary adjustments have been made, click OK. All the tubes are detected with a 100% accuracy.

2.2 Tube auto-detection based on a photo

When detecting the tubes on a picture, a few simple steps are required to optimize the detection.

2.2.1 Rotating the photo

The picture can be rotated if the rows of tubes in your photo are not parallel to the axis in the software.

To do so, in the *PHOTO* tab, click on the *Rotate Left* and *Rotate Right* buttons.

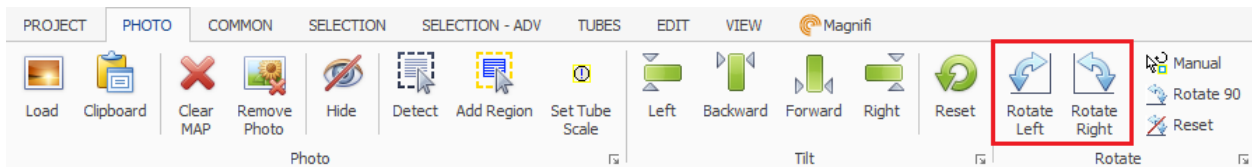

For example, here's a photo where the tube rows are not horizontal.

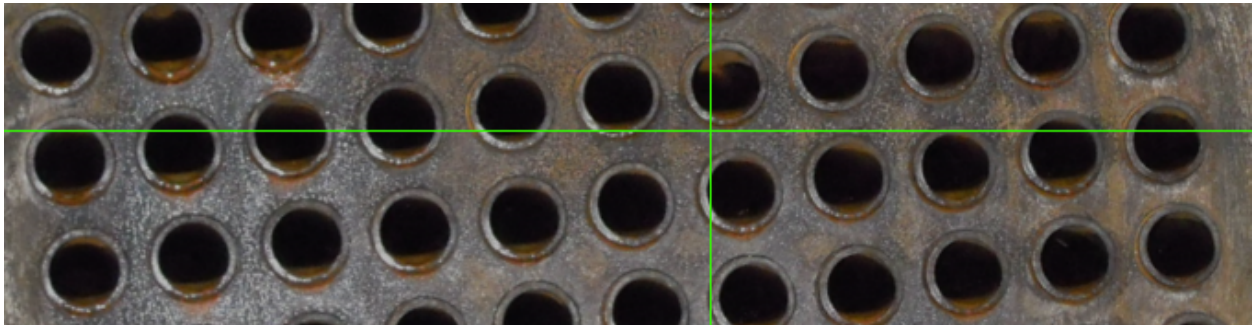

Below, the photo has been rotated by clicking *Rotate Right*.

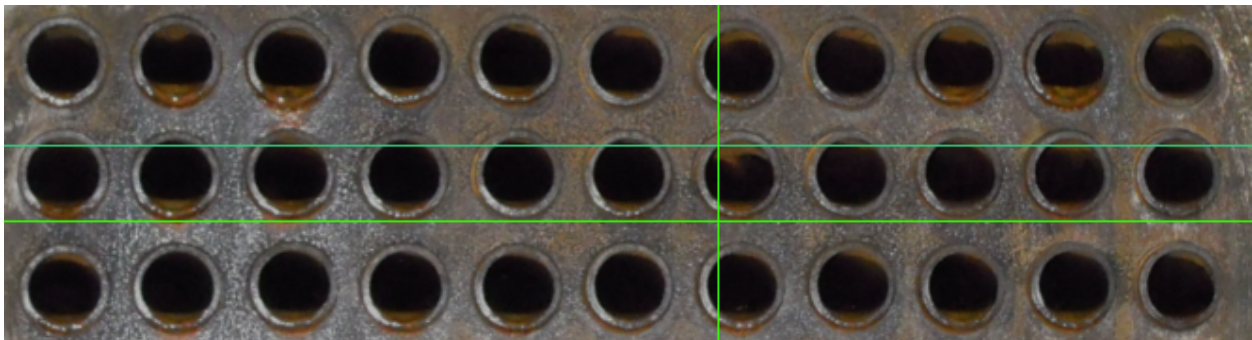

2.2.2 Tilting the photo

If your camera was not centered and/or parallel to the tube sheet when the photo was taken, some tubes may seem smaller than they are. This will also lead to uneven apparent distance between the tubes.

To correct this effect, it is possible to tilt the sides of the photo. In the *PHOTO* tab, click on the appropriate *Tilt* button. The tilting effect can be cancelled by using the *Reset* button.

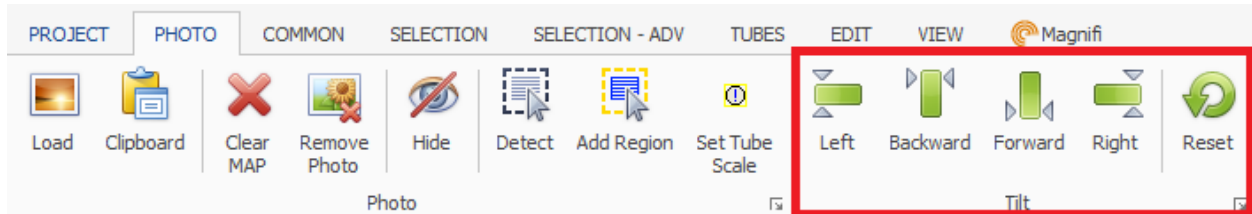

Finally, the picture is ready for detection. All remains to be done is to Click on the *Detect* icon.

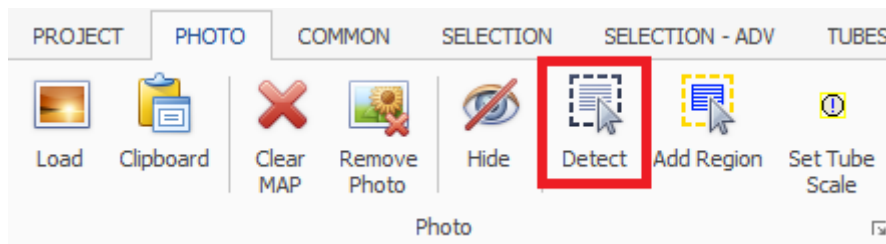

Select the area where you want to software to detect tubes. For larger tube sheets, it is advanced to do multiple detection zones. It helps to detect more tubes and the detected tubes will not be duplicated.

The detection sensitivity can be adjusted with the scrolling bar at the top of the main view. If some tubes are missing, you can use manual tools to add the remaining tubes.

2.2.3 Specifying the scale on a photo

Now that the tube sheet as been created, the relative measurement between the computer screen and the picture needs to be set. This way, the system will be able to draw the tubes with dimensions that will match the imported photo.

To start, a tube needs to be selected. After, in the *SELECTION* tab, click on *Tube Scale*:

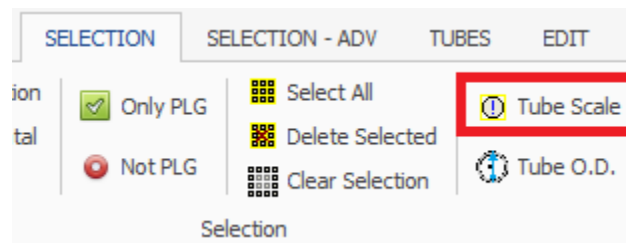

Specify the tube outer diameter that is shown on the picture using the *Tube Diameter* field.

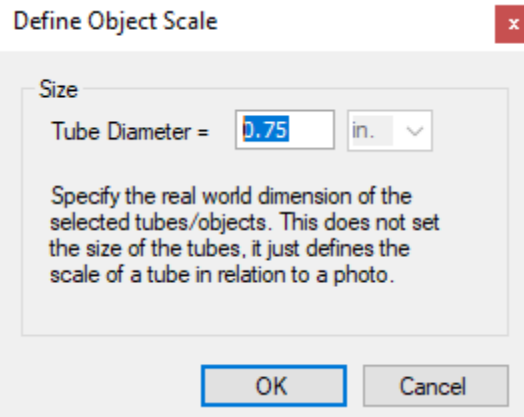

In order to make sure that all the tubes in your bundle have the same OD, select them all and click on the *Tube O.D.* button in the *COMMON* tab.

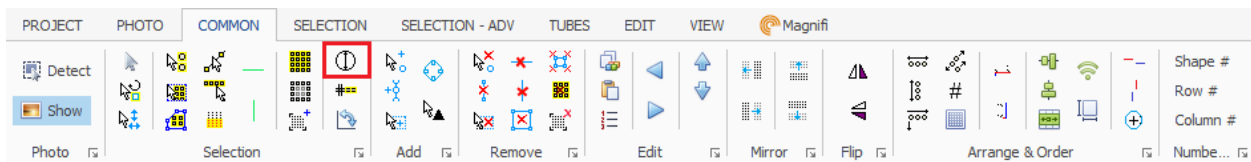

Specify the size of your tubes.

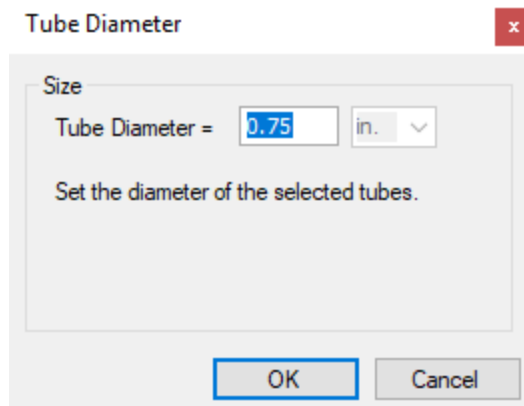

2.2.4 Set the OD for all the tubes

Now that the scale has been set, the OD of all the tubes will have to be defined. To do so, go in the *COMMON* ribbon, click on the tool *Select All Tubes*.

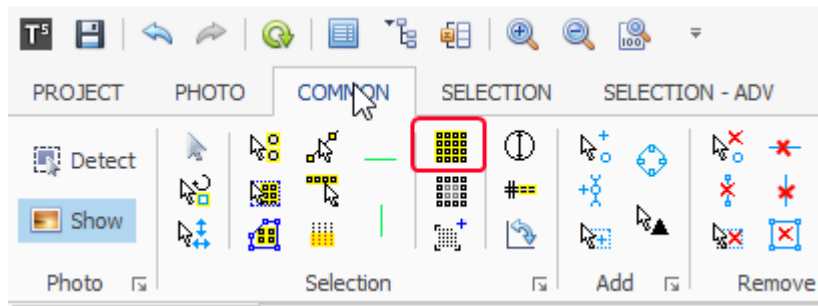

Then, just next to it, use the *Set Tube OD* tool.

Tube OD can also be set when all the tubes are selected by changing the value of the Properties in the right side menu.

2.3 Inserting a rectangular block of tubes

In the *Project* tab, select *Insert Block* and choose *Rectangular block of tube*.

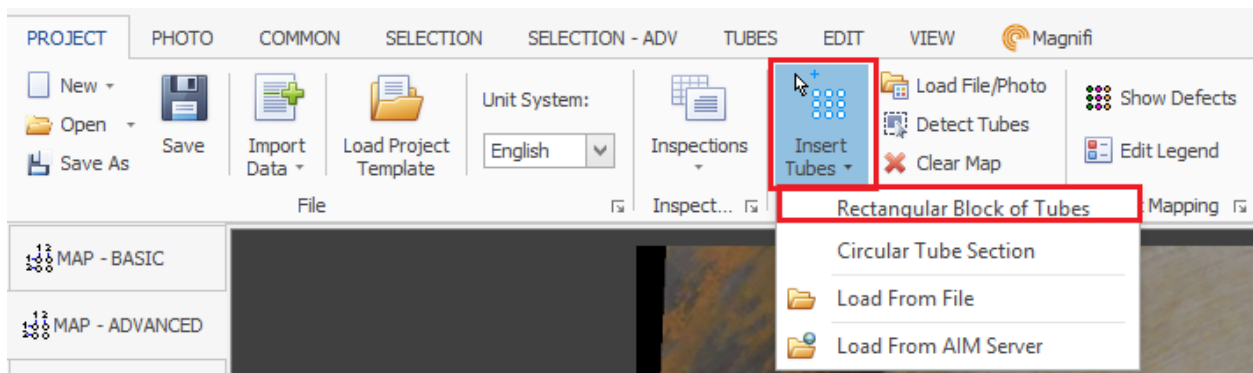

A window appears to define the parameters of the block:

Add Tube Area
✕

Rectangular Block

General

Section Name:

Geometry

# Rows:	<input style="width: 50%;" type="text" value="10"/>	# Tubes/Row	<input style="width: 50%;" type="text" value="10"/>
Tube Diameter:	<input style="width: 50%;" type="text" value="0.75"/> in.	Wall Thickness:	<input style="width: 50%;" type="text" value="0.125"/> in.
X - Position:	<input style="width: 50%;" type="text" value="7.3"/> in.	Y - Position:	<input style="width: 50%;" type="text" value="-4.378"/> in.

Specify by Pitch and Pattern in.

Pitch: in.

Pattern:

Specify by Center Distances

Horizontal: in.

Vertical: in.

There are 2 possible options to define the geometry of your block: *Specify by Pitch and Pattern* or *Specify by Center Distance*

The *Pitch* is the height between the center of tubes of two adjacent rows.

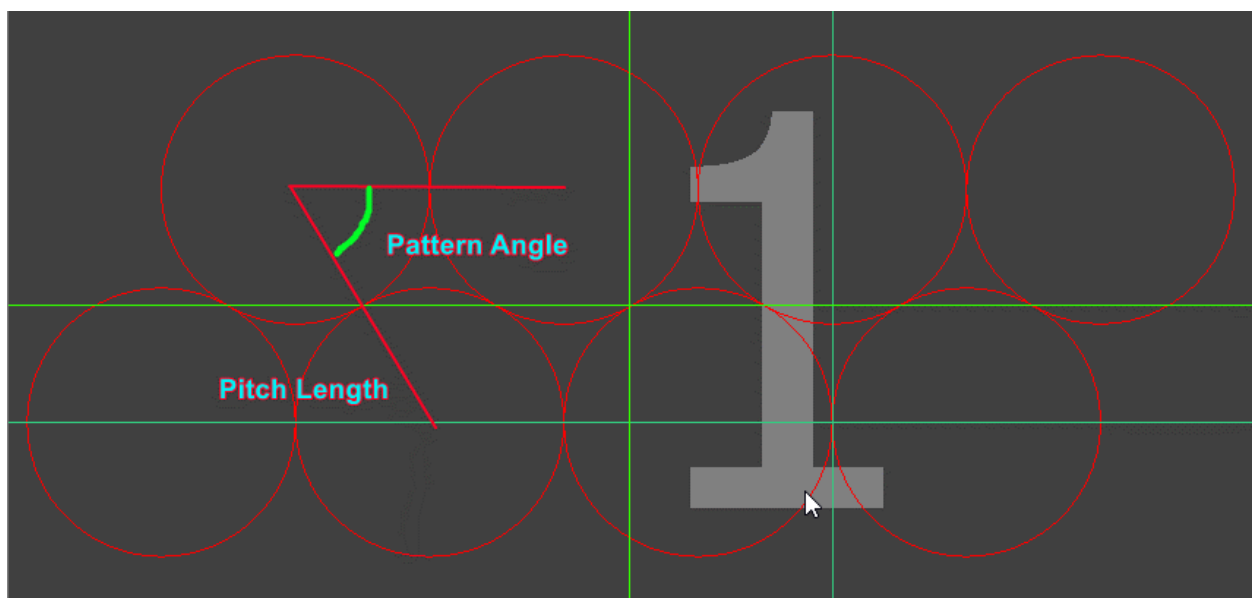

2.4 Inserting a single tube

Select the *MAP – ADVANCED* subsection.

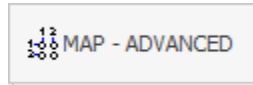

In the *COMMON* ribbon, select *Single*.

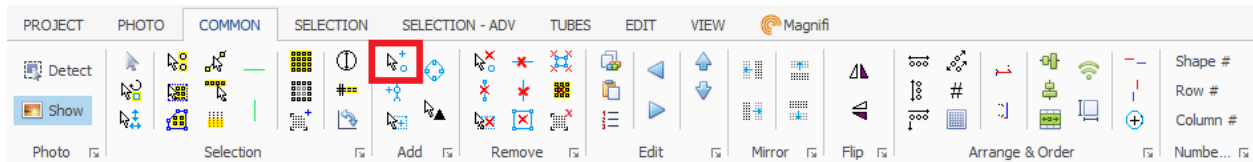

Click on the location where you want to add a tube.

2.5 Selecting tubes

In the *Edit* tab, select the *area* button.

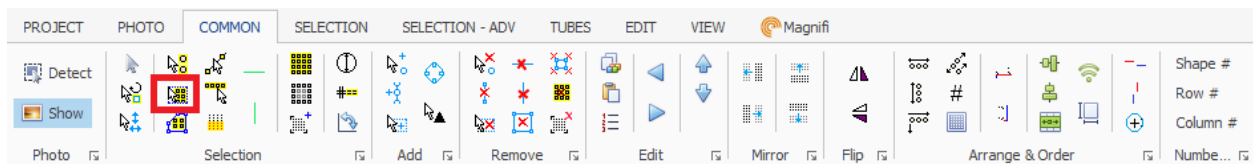

Surround the section you want to select.

The same operations can be done with the other options in the *Select* group of function.

2.6 Moving tubes

Select the section you want to move with the previous functions.

Click on the *Move* button in the *COMMON* tab

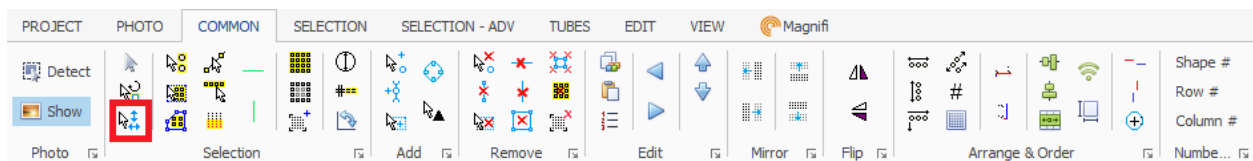

Select the reference point and then select your destination point. The selected section will move by the distance difference between the 2 specified points.

You can also change the orientation of your bundle by using the *Rotate* function in the *COMMON* tab.

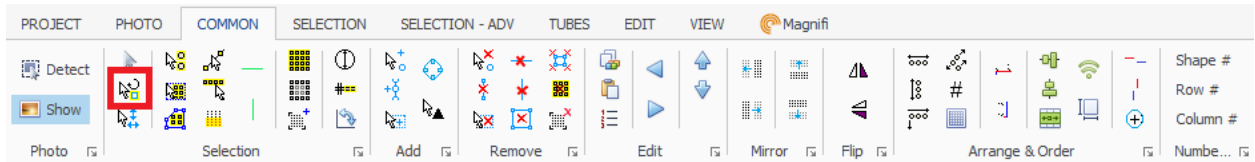

Select the tubes that you want to rotate and hit the *Rotate* button in the *COMMON* tab. Click on the center of the rotation and then click at another point in your map to create a reference axis. To finish the rotation, click on another point where you want your reference axel to move to complete the rotation.

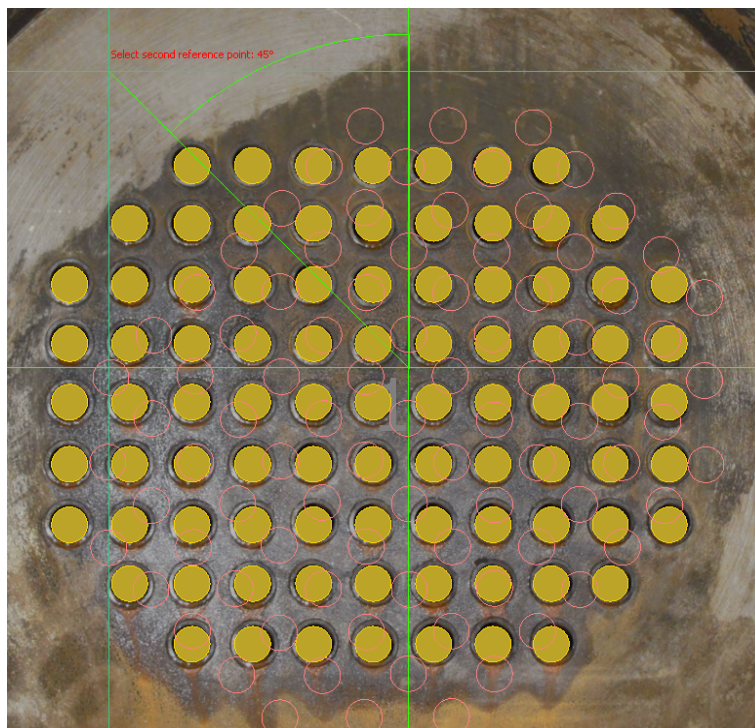

2.7 Deleting tubes

Click on the *Remove Area* button in the *COMMON* tab

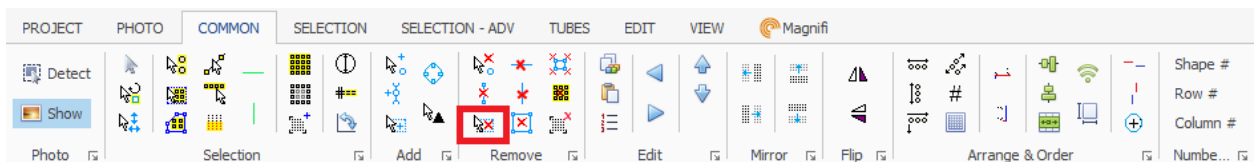

Surround the section you want to delete.



Other options are available in the *Remove* group of functions.

2.8 Aligning a selection of tubes

Select the tubes you want to align.

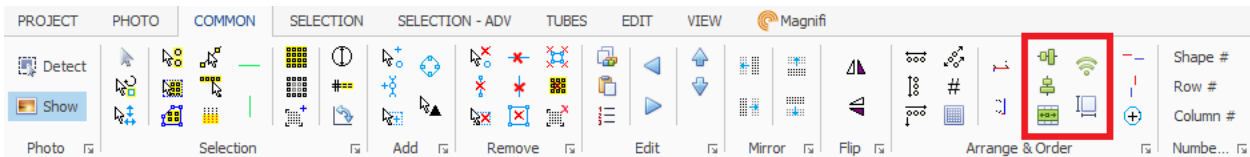

Click on the button that correspond to the alignment you want in the *Align* subsection of the *SELECTION* tab.

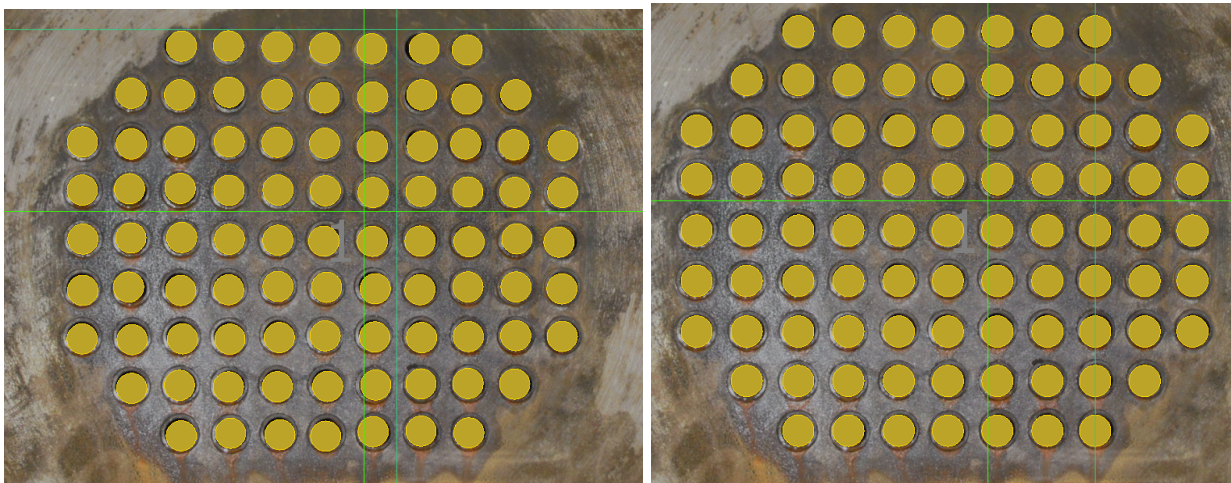

The most commonly used buttons are *Align vertically*  and *Align horizontally* . These buttons align the center of the tubes, either horizontally or vertically, if they are close enough from each other. They are used to align multiple rows and columns of tubes at the same time.

Here is an example of tubes before and after they've been aligned, both horizontally and vertically. The positions of the tubes' center before the alignment are slightly offset from each other whilst after the alignment they are arranged in grid pattern.



The join buttons relocate all the tubes selected on the same horizontal  or vertical  line. This tool is used for just a single line, not the whole tube sheet.

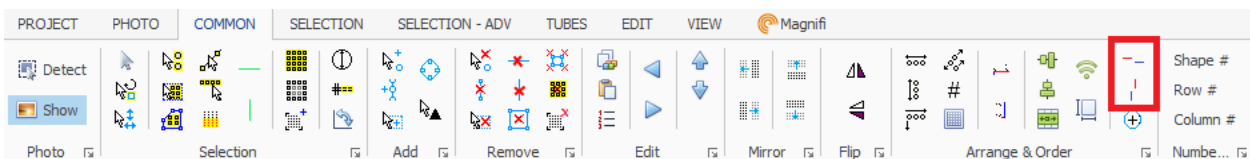

Here's an example of tubes that have been joined vertically.

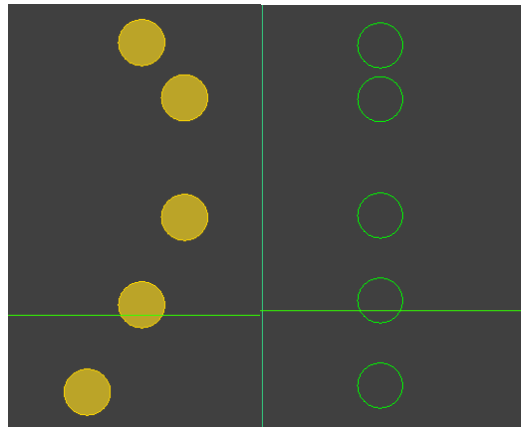

2.9 Adjusting the numbering

TubePro has different tools to help you create the exact numbering you are looking for.

To view, the current numbering, select the *Row* and *Column* options in the *VIEW* tab

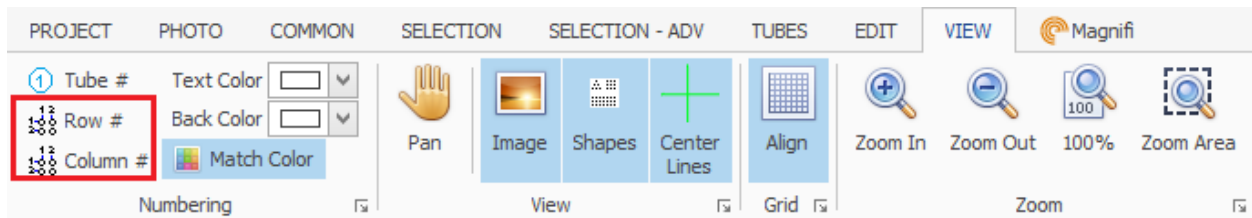

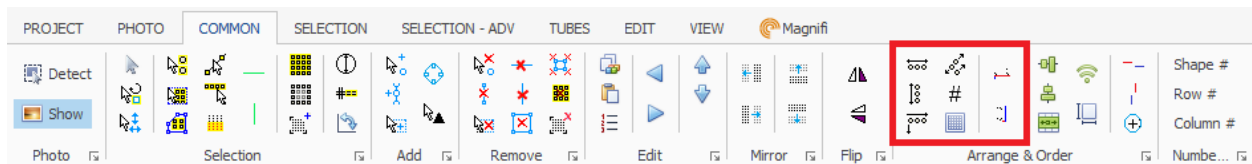

The *Tube #* tool can also be used to show each tube's row and column. The numbering settings can be found in the *Arrange & Order* function group under the *COMMON* tab.

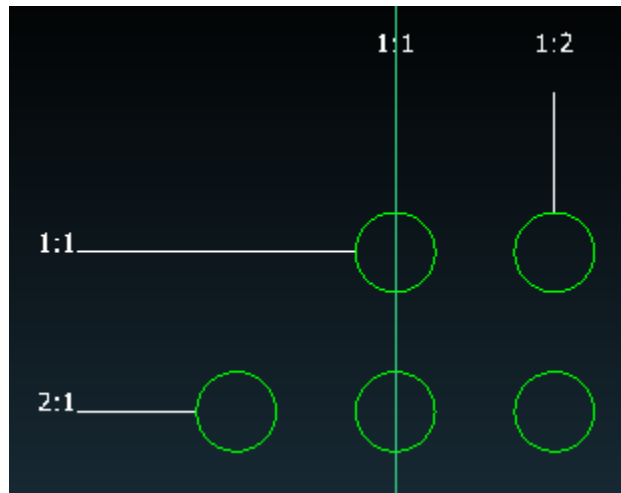

Tubes can be identified by row and column with the following format: X:Y, where X is the row and Y is the column number. The reference number 1:1 can be set in different ways.

The option *Rows are horizontal*  set the 1:1 tube as the first tube of the first row of the bundle. In this case X is the row number.



The option *Rows are vertical*  set the 1:1 tube as the first tube of the first column of the bundle. In this case X is the column number.

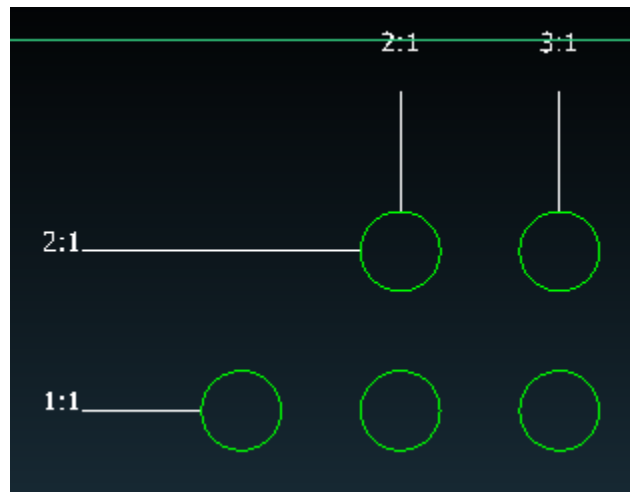

Tubes can also be identified with a single number by selecting a third numbering option  :

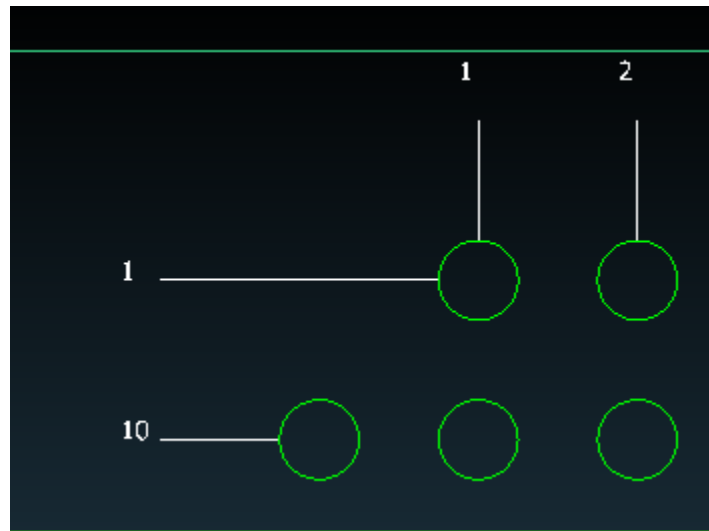

The numbering order can be reversed horizontally or vertically by selecting the following options:



These tools can be used if to switch the numbering from left-to-right to right-to-left, or from top-to-bottom to bottom-to-top.

Another numbering method that is available to you in *TubePro 5.4* is the *Grid* method which numbers the tubes on a grid. To do so, click on the *Use Grid Numbering* under the *COMMON* tab.

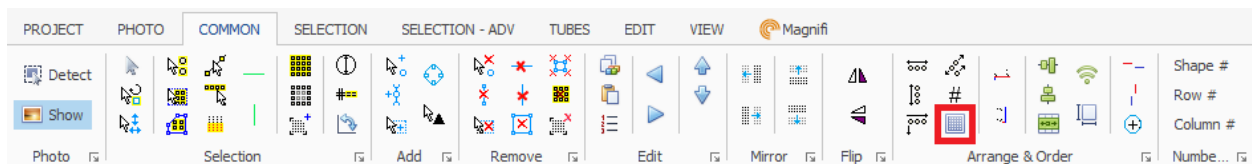

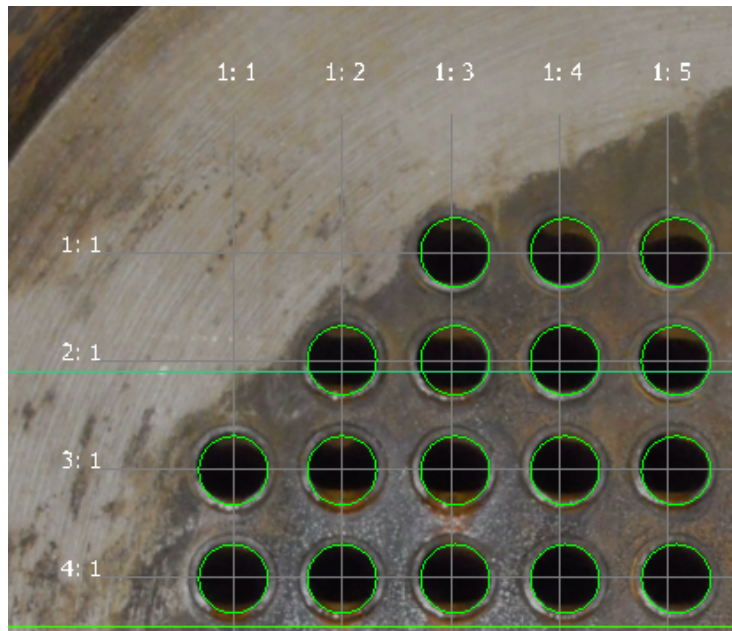

2.10 Creating and assigning a section

A section identifier can be added to parts of a bundle. It can be used to defined the numbering.

To define a section:

- Select the tubes you want to add to a section
- Click on the *Add Selected Tubes to Section* button in the *TUBES* tab.
- Select the section in the list.

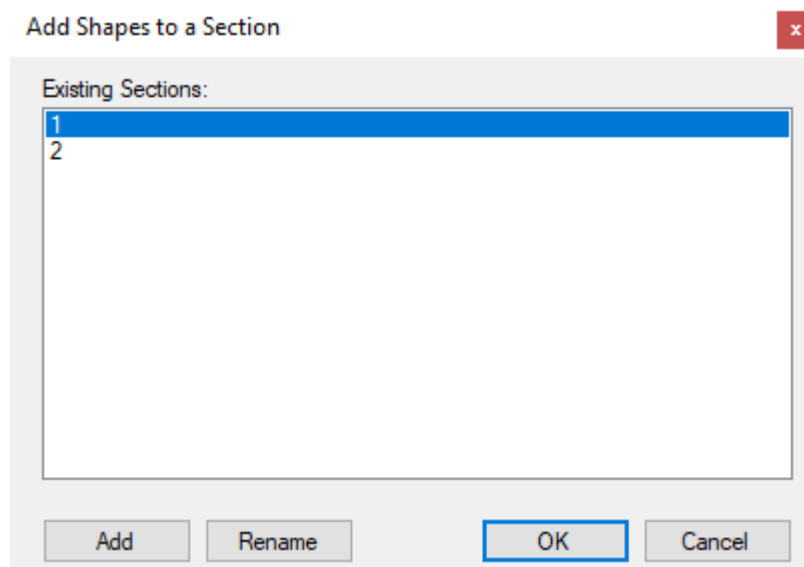

If you want to create a new section, click on *Add* and enter the name of the new section.

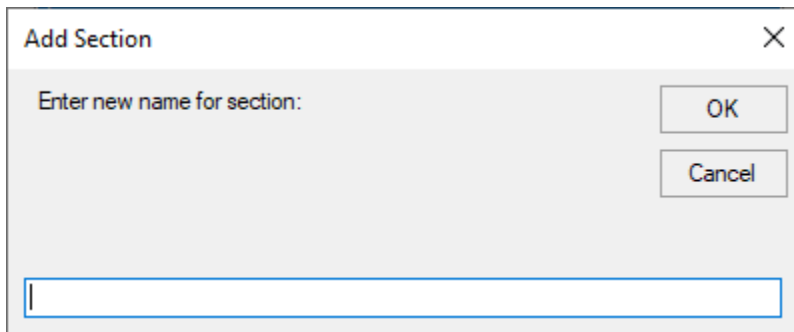

Click on OK to apply the changes.

2.11 Exporting a tube list

Once your mapping is done, you can export your tube list to use it in your acquisition software.

Click on the *Export* button in the *TUBES* tab

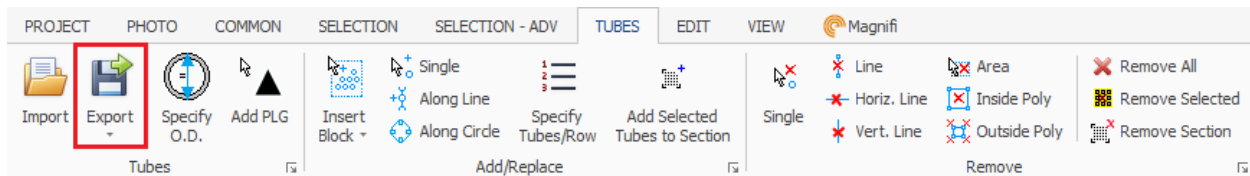

Select the LST format to use the list with Magnifi:

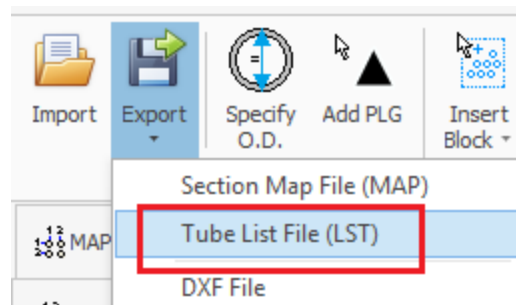

And save the file in the chosen destination.

3. 3D MODEL

The following settings and functions can be found in the *3D MODEL* tab located on the left side of the main window. They are used to build a 3D representation of an exchanger.

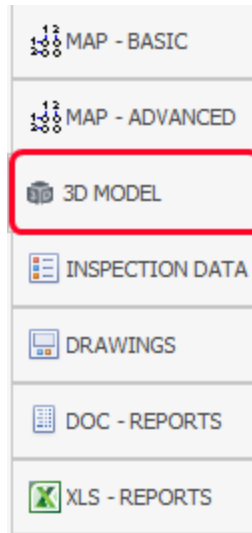

3.1 Display functions

A set of function in the upper center of the main window of the *3D MODEL* tab allows you to change the angle at which you want to visualize your bundle model.

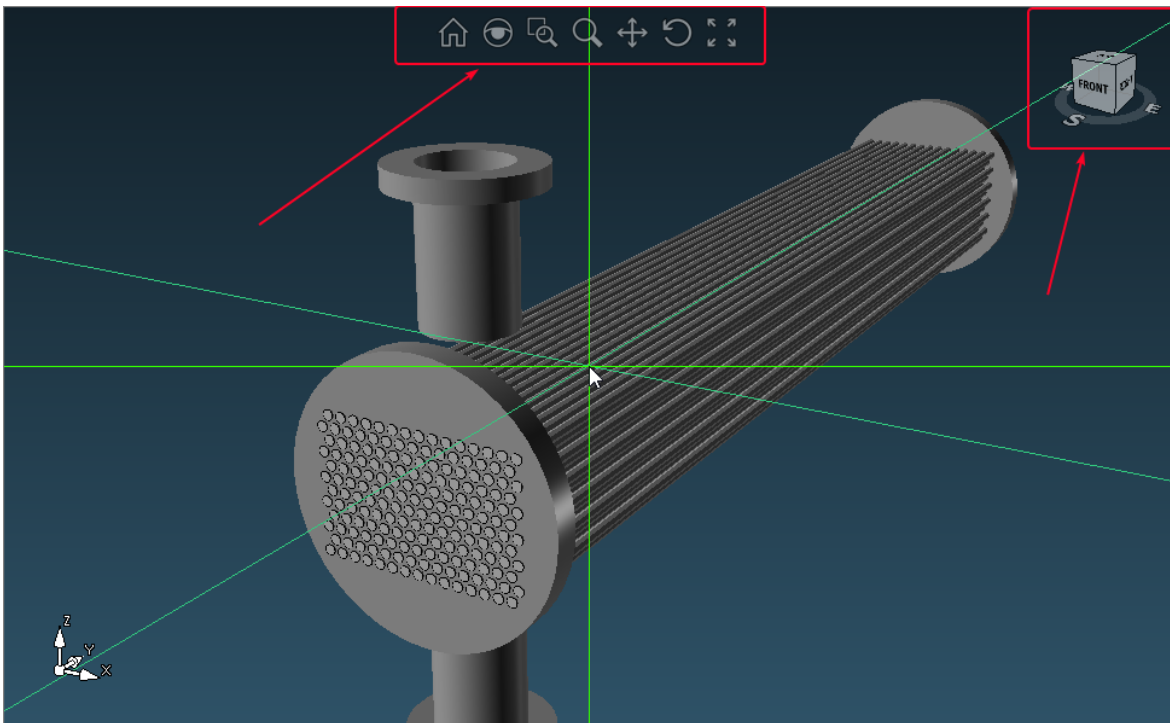

It is also possible to select a visualization angle by using the cube at the upper right of the main window. Clicking on a section of this cube will rotate and adjust your bundle to the corresponding angle.

Zooming in or out can be done by using the wheel on your mouse. The 3D view can be panned by holding right button of the mouse while moving the mouse. Rotating the bundle can be done the same way but with the left button of the mouse.

3.2 Tube properties

The length and type of tubes can be adjusted in the *Bundle Geometry* settings at the right side of the interface in the *Project Browser*:

Bundle Geometry	
Unit Type	Straight Through Bundle
Tube Length[in]	200
Test Tubes From	Front
Measure Supports From	Front
Center Component on S...	Yes
Bundle Offset X[in]	0
Bundle Offset Y[in]	0
Bundle Rotation[in]	0

Tube length must correspond to your inspection data. If flaws are tagged outside this length range, they will be shown outside of the bundle in the 3D model.

3.3 Tube sheet Geometry

Tube sheet geometry settings can be found at the right side of the interface in the *Project Browser*;

Tubesheet Geometry	
Tubesheet Type	Circular
Tubesheet Thickness[in]	2
Circular Tubesheet Geometry	
Front Diameter [in]	30
Rear Diameter [in]	30
Rectangular Tubesheet Geometry	
Top Width[in]	30
Bottom Width[in]	30
Height[in]	30

It is also accessible under the MODEL tab:

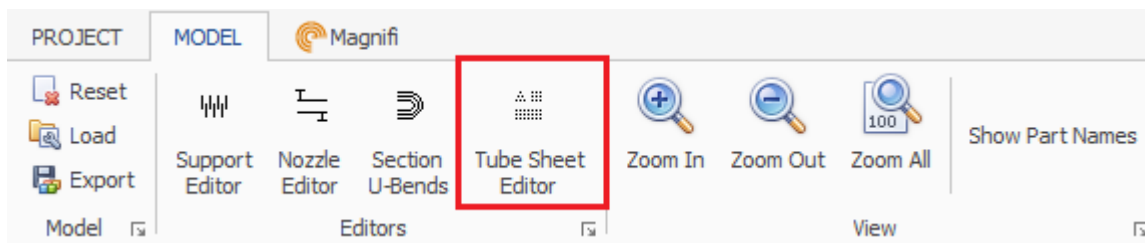

To add a tube sheet, click on *Add*

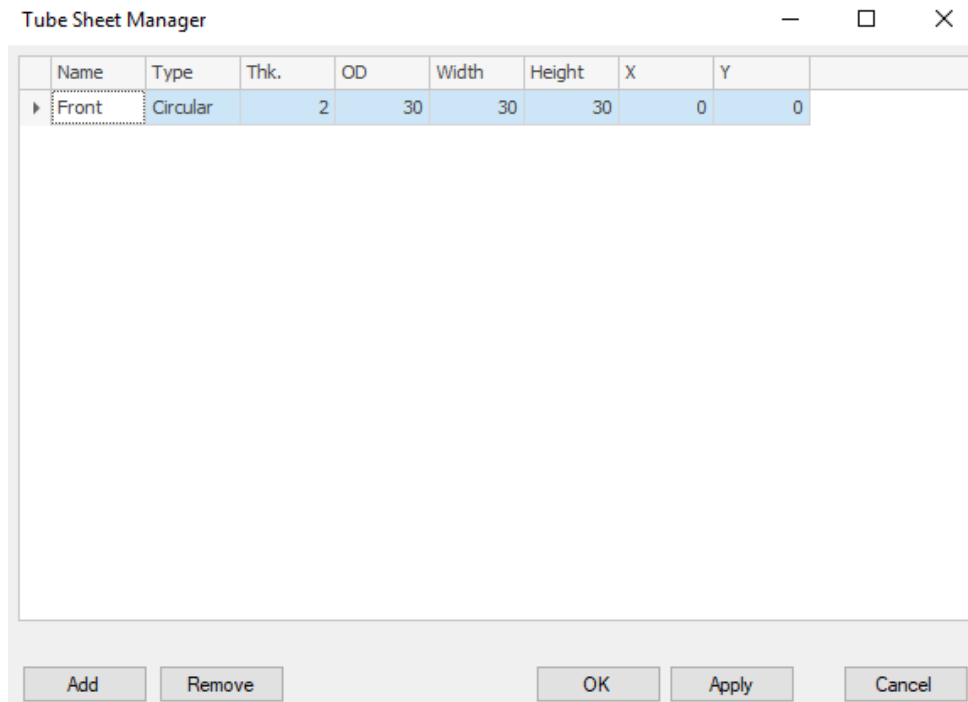

A table showing a list of tube sheet parameters will appear. Properties can be modified by changing the values in this table.

Click on *Apply* to apply the modification to your model.

3.4 Support plates

Support plates can be added to your bundle by clicking on the *Support Editor* button under the *MODEL* tab.

To add a set of support plate, click on *Add*

Supports & Landmarks — □ ×

	Name	Type	Tube...	Locat...	Diam...	Thick...	Cut	1st El...	Oute...	Inner...	# Ele...	Spaci...	Rotation
I	SP1	Singl...	Front	10	30	0.25	Vertical	N/A	9.9	9.9	10	10	0

Add
Remove

A table showing a list of support plates parameters will appear. Properties such as the type of support plate, the number of support and the distance between them can be modified by changing the values in this table.

Click on *Apply* to apply the modifications to your model.

3.5 Nozzles

Nozzles can be added to your bundle by clicking on the *Nozzle Editor* button under the *MODEL* tab.

To add a nozzle, click on *Add*

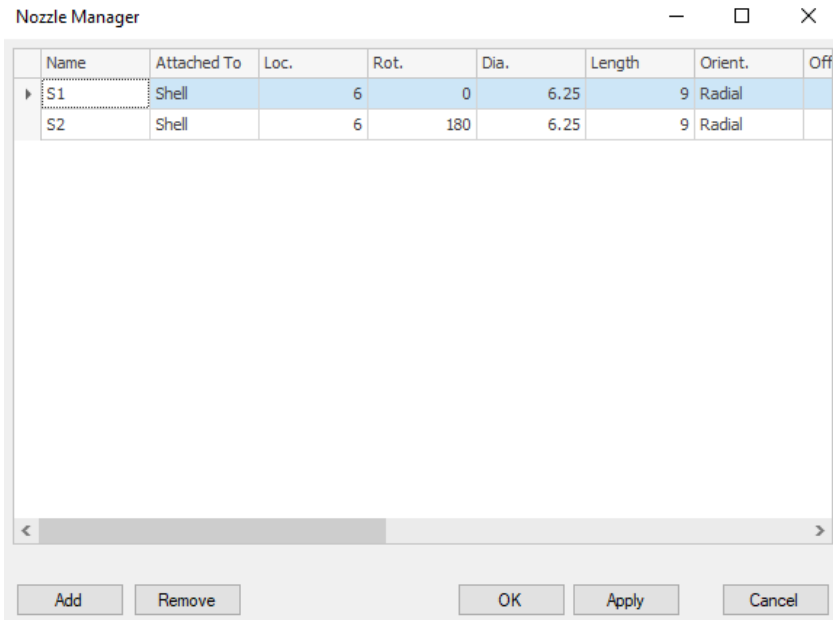

A table showing a list of nozzle parameters will appear. Properties can be modified by changing the values in this table.

Click on *Apply* to apply the modifications to your model.

3.6 U-Bends

To build 3D model of a heat exchanger with u-bends:

In the *Properties* tab of the *Project Browser* select the bundle *Unit Type* to *U-Bends Sections*.

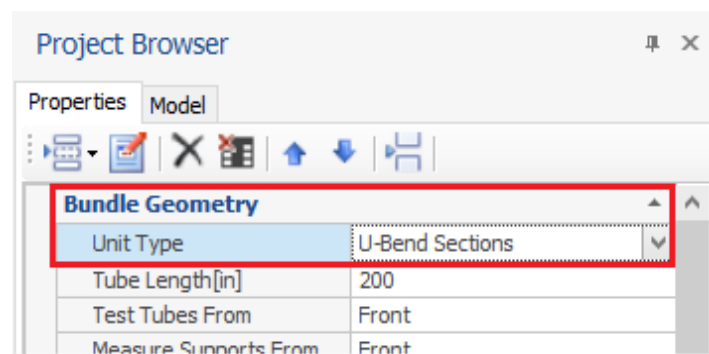

If the parts of the bundle that needs to be connected by a U-Bend mirror each other, then the U-Bend will automatically be created after the selection of this *Unit Type*.

4. INSPECTION DATA

TubePro will create a tube list based on the tube mapping build in the *MAP* tabs. This list can be found in the *INSPECTION DATA* tab.

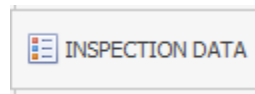

4.1 Importing data from an acquisition software

Once the acquisition of you bundle is completed, you can import the report created with your acquisition software.

In the *PROJECT* tab, click on *Import Data*

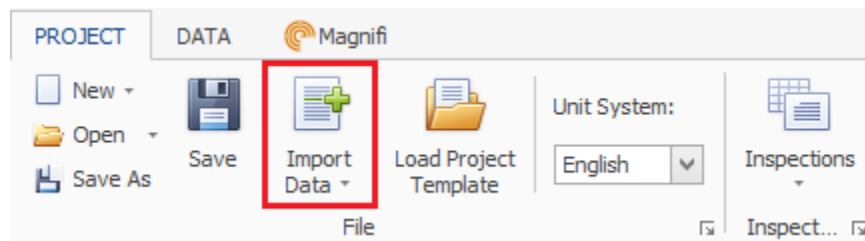

You can either replace the set of data or append the imported data:

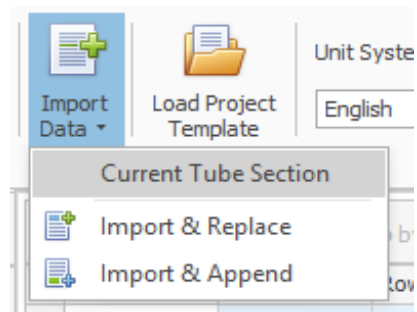

The software will display the flaws in your 3D representation based on the *Location* and *Extent* field.

A legend can also be built in order to show the degree of deterioration of the tube based on fields relative to this information (*percentage*, *Actual Wall Loss*, ...). This option can be found under the *DRAWING* tab.

5. DRAWINGS

Drawings are customizable pages that can include relevant information such as 2D and 3D representation of your bundle, graph and color legends. They can be inserted as a full page in your report.

The following settings and functions can be found in the *DRAWING* tab.

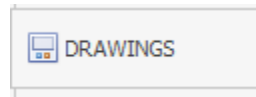

5.1 Adding a drawing page

Click on the *New* button under the *DRAWING* tab:

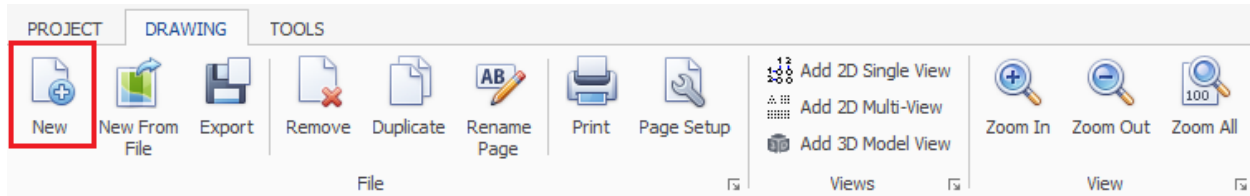

Select the desired template and click OK.

5.2 Changing a drawing page layout

Click on the *Page Setup* button under the *DRAWING* tab

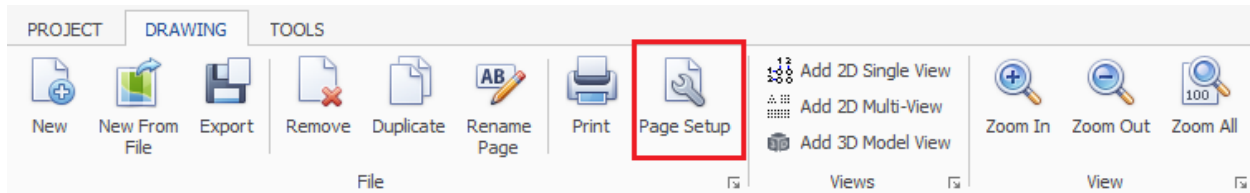

Change the parameters to the desired values.

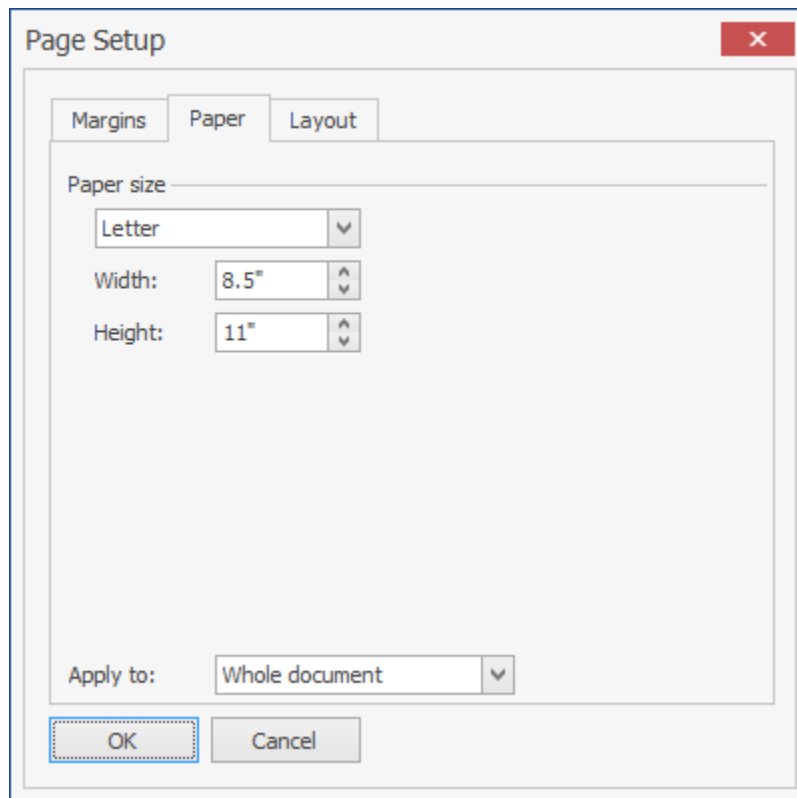

5.3 Inserting an element in a drawing

Select the *Project* tab in the *Project Browser* window at the right side of the interface:

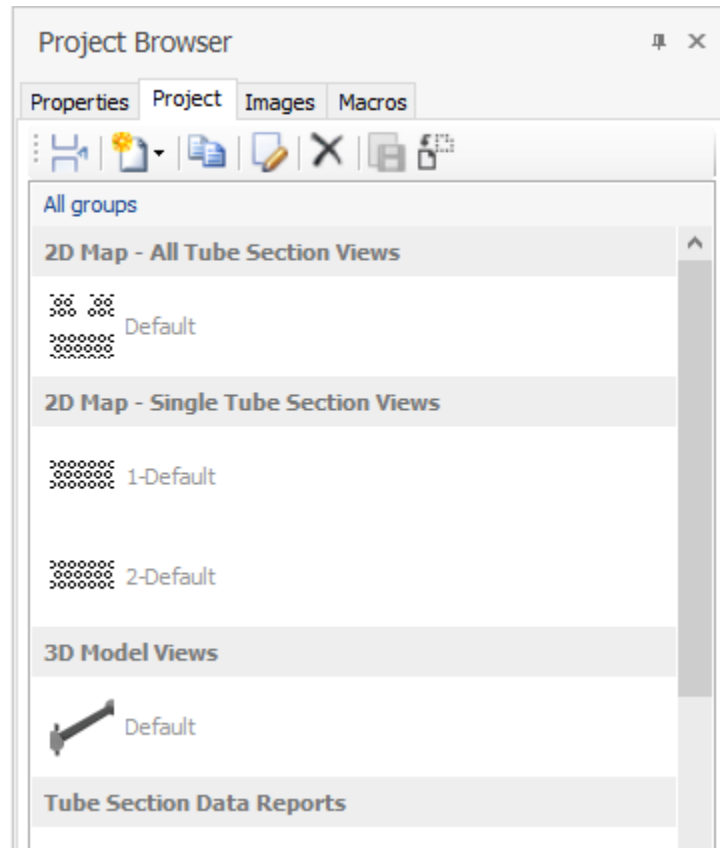

Different groups of elements can be found under this tab. These different items can be easily dragged and dropped from the list to your drawing. To edit the parameters of an element, simply double-clicking on it. You can move an element in a drawing page by dragging it with the left button of the mouse.

If an element is not up to date with the latest defects, simply press the *Refresh* button in the *Quick Access* toolbar.

5.4 Create an element

Elements can be created to show, for instance, your 3D model for a given orientation.

Select the *Project* tab in the *Project Browser* window at the right side of the interface.

Click on the *New Report Element* button in the upper list of functions of this tab.

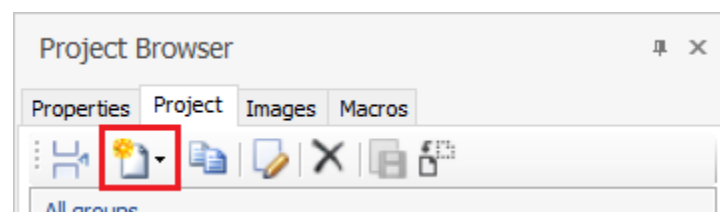

Select the type of element you want to add

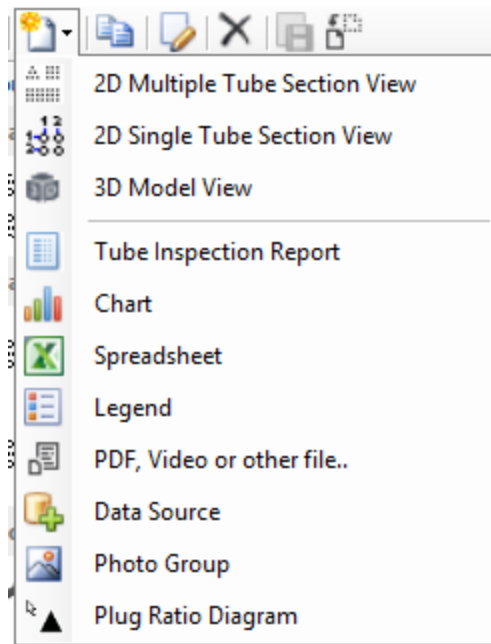

If applicable, enter the requested parameters.

The newly added element will be available in the element list. Parameters can also be modified by double clicking on it in the *Project browser*.

6. REPORT

Starting with version 5.4, it is now possible for the user to create a report based on a text template or a spreadsheet template. The tables and pagination tools of Word can be used to enhance your report and all the representations, images, drawings and defect tables will be displayed. On the other hand, spreadsheets allow for calculation-based tools. Regardless of the format, all the Field Codes entered in your report will be linked and automatically updated.

To access the report, simply select its section on the left side menu.

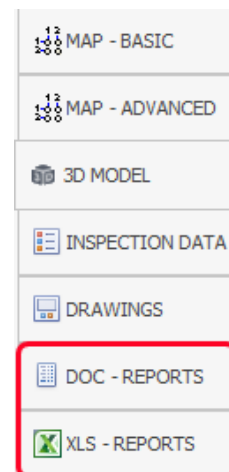

6.1 Page Layout

To modify the layout of your report:

Go to the *PAGE LAYOUT* tab

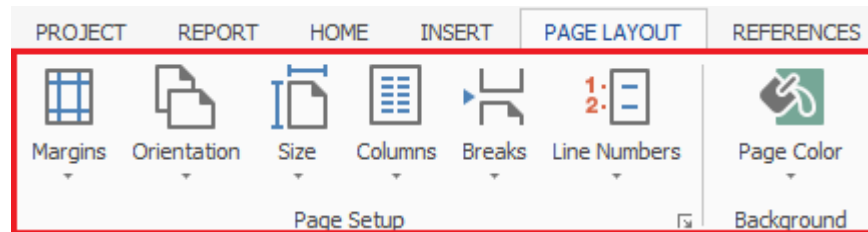

Parameters such as the page orientation, margin dimensions or the number column can be adjusted there.

6.2 Inserting a field

Variable that are linked to a single editable field can be inserted in the report. This allows the user to modify information, such as the client name for instance, at only one place even if this information is found at multiple places in the report.

Two techniques can be used to insert a field in you report:

6.2.1 Drag and drop method:

- Go to the Project Browser at the right of the screen
- Click on the variable you want to insert in the report and hold button.
- Drag and drop it to the chosen location.

6.2.2 Double-click method:

- In the Word document, place the cursor where you want to add the *Field Code*.
- On the right-side menu, double-click on the property you want to add.

6.3 Creating a field

Go to the *Properties* tab of the *Project Browser*

Click on the first icon in the top left

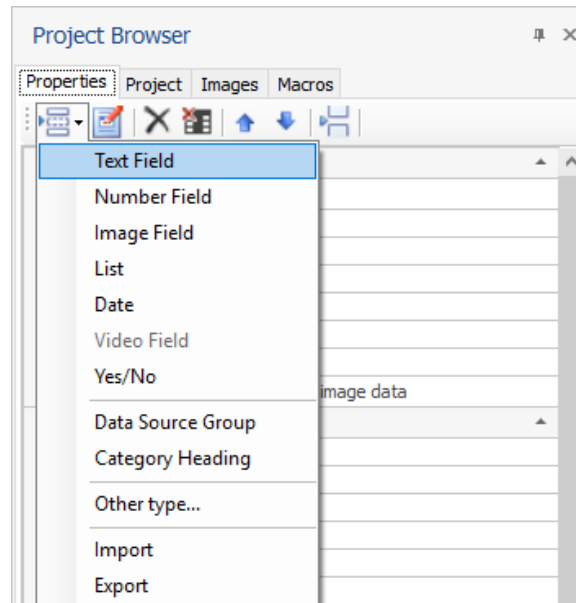

Select the type of field you want to create and configure its parameters. The new property will be available on the *Properties* tab of the *Project Browser*.

6.4 Inserting an element

Go to the *Project* tab of the *Project Browser*

Drag and drop the desired item to the desired location.

6.5 Exporting a report

When satisfied with the result, it is then possible to generate the report from the interface. Simply click on the *Build PDF Report* icon and the following window will be displayed:

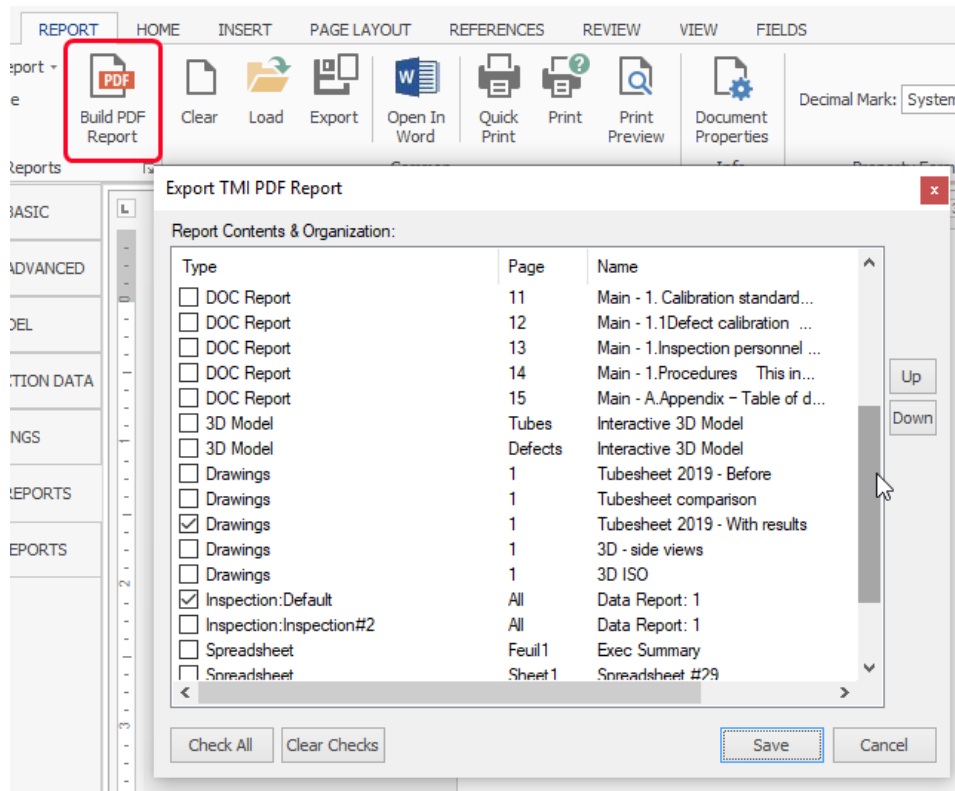

Page by page, you will be able to choose the content of your report. The order in which it is presented in the list is the order in which the pages will be assembled.

With this menu, it is then possible to arrange a PDF that contains DOC pages, XLS pages as well as all the other item types.

Once the pages have been selected, you can then click on *Save* and the Windows explorer will be displayed so you can choose the desired location for the file.

6.5.1 3D model in the report

Starting with 5.4, it is now possible to insert the actual 3D model in your PDF report. When the report is then sent to a client, the later can then change the appearance of the model to his likings. For an example of the end result, you can follow this link to a demonstrative video: <https://youtu.be/kUr4ffDv8AM>.

To insert a 3D model, you need to select the *Drawings* with a name that starts with *3D*.

The information in this document is accurate as of its publication. Actual products may differ from those presented herein. © 2021 Eddyfi Technologies. Eddyfi, TubePro, Magnifi, Ectane, Reddy and their associated logos are trademarks or registered trademarks of Eddyfi in the United States and/or other countries. Eddyfi reserves itself the right to change product offerings and specifications without notice.15/09/21.

www.eddyfi.com

info@eddyfi.com

